

All innovation
on driving your valve automation

Solenoid Valve (5/2 way Cy 0 9) .



Explosion proof solenoid valve for a confident control under rough working environments

Features

- ▶ Rugged aluminum die-cast housing or Stainless steel 316
- ▶ Rotaable valve head for optimal mounting
- ▶ Direct NAMUR mounting or screw mounting
- ▶ Usable up to SIL3 acc. to IEC 61508
- ▶ KC - certified flameproof Ex d IIC T6 / T5
- ▶ NEPSI - certified flameproof Ex d IIC T6 / T5
- ▶ IECEX - certified flameproof Ex d IIC T6 / T5
- ▶ ATEX - certified flameproof Ex d IIC T6 / T5

Specifications

Model	ESV-S	ESV-D
Operating Air Pressure	1.5 - 10 bar	
Air Supply (Max.)	15 bar	
Operating Voltage / Power	AC110V : 6.1VA / AC220V : 3.8VA / DC 24V : 3.4W	
Voltage Tolerance	10%	
Frequency	50Hz / 60Hz	
Explosion Proof Class	Ex d IIC T6 / T5, IP66	
Operating Ambient Temperature	T6 : -30 - +60 T5 : -30 - +80	
Flow Capacity(Cv)	0.9	
Mounting Configuration	NAMUR or screw interface	
Pneumatic Connections	PT(Rc) 1/4 or NPT 1/4	
Electrical Connection	PF(G) 1/2 or NPT 1/2	
Coil Insulation Grade	Class F / Class H	
Operating type	Single coil	Dual coil
Duty Cycle	100%	
Valve body material	Aluminum die-cast or Stainless steel 316	
Coil housing material	Aluminum die-cast or Stainless steel 316	
Weight (Valve body / Coil housing)	Aluminum / Aluminum : 0.9 kg Aluminum / SS316 : 1.9 kg SS316 / SS316 : 2.3 kg	Aluminum / Aluminum : 1.4 kg Aluminum / SS316 : 2.5 kg SS316 / SS316 : 3.3 kg

Rotatable Valve Head

The ESV valve head can be rotated by 90° to the right or to the left for an optimal mounting as shown below

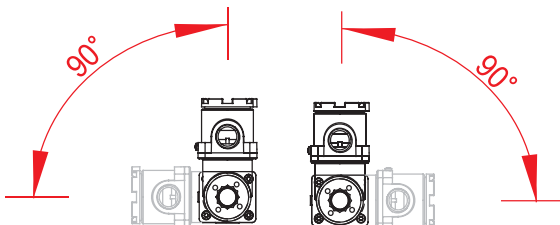

Mounting

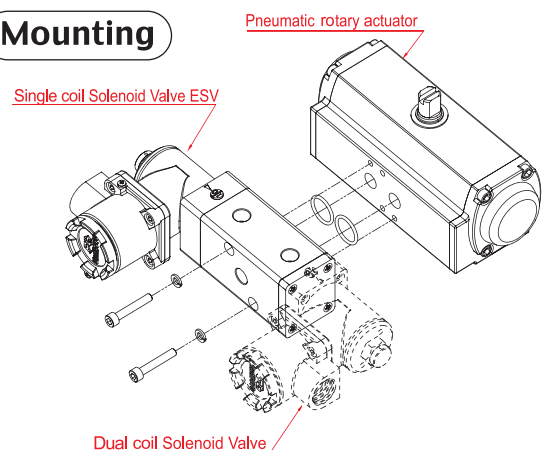

Solenoid Valve (3/2 way, Cv 0.09)



Explosion proof solenoid valve for a confident control under rough working environments

Features

- ▶ Rugged aluminum die-cast housing or Stainless steel 316
- ▶ Rotatable valve head for optimal mounting
- ▶ Screw mounting
- ▶ Usable up to SIL3 acc. to IEC 61508
- ▶ KC - certified flameproof Ex d IIC T6 / T5
- ▶ NEPSI - certified flameproof Ex d IIC T6 / T5
- ▶ IECEX - certified flameproof Ex d IIC T6 / T5
- ▶ ATEX - certified flameproof Ex d IIC T6 / T5

Specifications

Model	ESV-3	ESV-3S	ESV-3C
Orifice Size (Cv)		Ø 1.6 (0.09)	
Operating Air Pressure		1.5 - 7 bar	
Operating Voltage / Power	AC110V : 9.9VA / AC220V : 9.7VA / DC 24V : 4.8W		
Voltage Tolerance		10%	
Frequency		50Hz / 60Hz	
Explosion Proof Class		Ex d IIC T6 / T5, IP66	
Operating Ambient Temperature		T6 : -30 - +60 T5 : -30 - +80	
Flow Capacity		145 ℓ/min (6 bar)	
Mounting Configuration		Screw interface	
Pneumatic Connections	PT(Rc) 1/4 or NPT 1/4		NPT 1/4
Electrical Connection	PF(G) 1/2 or NPT 1/2		NPT 1/2
Coil Insulation Grade		Class F / Class H	
Duty Cycle		100%	
Valve body material	Aluminum	Stainless steel 316	Stainless steel 316
Coil housing material	Aluminum die-cast	Aluminum die-cast	Stainless steel 316
Weight	0.5 kg	0.8 kg	1.2 kg

Rotatable Valve Head

The ESV valve head can be rotated by 90° to the right or to the left for an optimal mounting as shown below

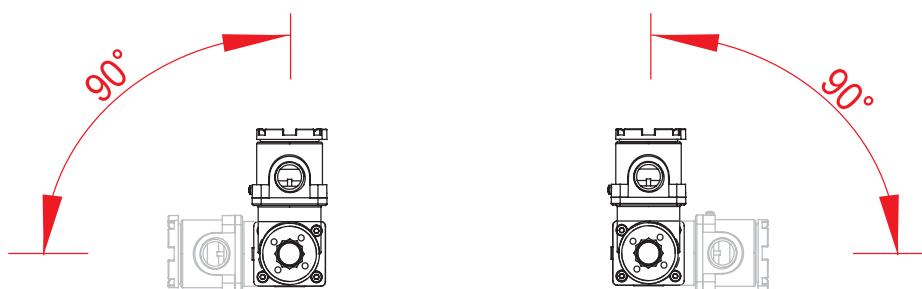

Solenoid Valve (3/2 way, Cv 0.9)



Explosion proof solenoid valve for a confident control under rough working environments

Features

- ▶ Rugged aluminum die-cast housing or Stainless steel 316
- ▶ Rotatable valve head for optimal mounting
- ▶ Screw mounting
- ▶ Usable up to SIL3 acc. to IEC 61508
- ▶ KC - certified flameproof Ex d IIC T6 / T5
- ▶ NEPSI - certified flameproof Ex d IIC T6 / T5
- ▶ IECEX - certified flameproof Ex d IIC T6 / T5
- ▶ ATEX - certified flameproof Ex d IIC T6 / T5

Specifications

Model	ESV-31	ESV-32
Operating Air Pressure	1.5 - 10 bar	
Air Supply (Max.)	15 bar	
Operating Voltage / Power	AC110V : 6.1VA / AC220V : 3.8VA / DC 24V : 3.4W	
Voltage Tolerance	10%	
Frequency	50Hz / 60Hz	
Explosion Proof Class	Ex d IIC T6 / T5, IP66	
Operating Ambient Temperature	T6 : -30 - +60 T5 : -30 - +80	
Flow Capacity(Cv)	0.9	
Mounting Configuration	Screw interface	
Pneumatic Connections	PT(Rc) 1/4 or NPT 1/4	
Electrical Connection	PF(G) 1/2 or NPT 1/2	
Coil Insulation Grade	Class F / Class H	
Operating type	Nomally - Closed	Nomally - Open
Duty Cycle	100%	
Valve body material	Aluminum die-cast or Stainless steel 316	
Coil housing material	Aluminum die-cast or Stainless steel 316	
Weight (Valve body / Coil housing)	Aluminum / Aluminum : 0.8 kg Aluminum / SS316 : 1.8 kg SS316 / SS316 : 2.1 kg	

Rotatable Valve Head

The ESV valve head can be rotated by 90° to the right or to the left for an optimal mounting as shown below

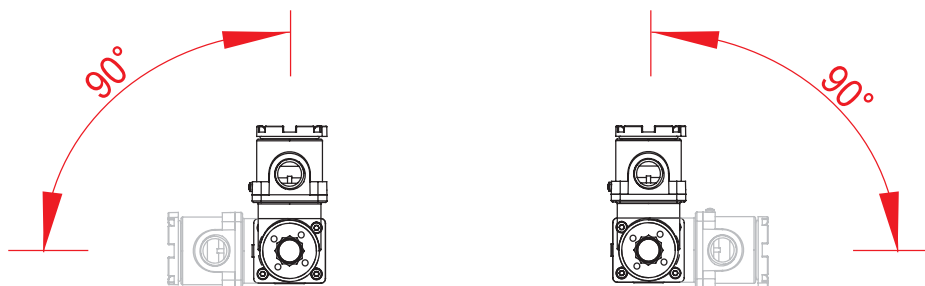

Ordering Guide

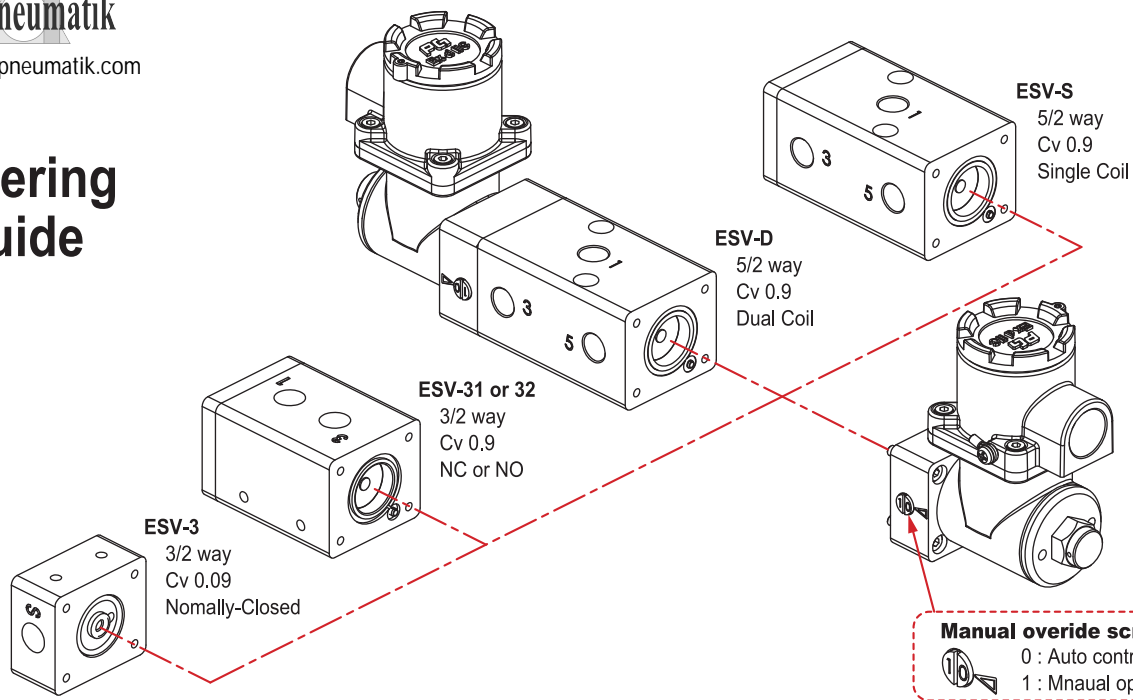

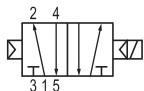
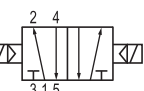
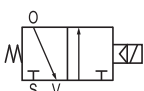
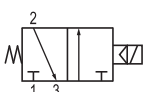
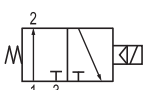
ESV Series	Operating Type	Body Material (valve body - coil housing)	Operating Voltage	Connections (pneumaitc - electrical)	Protection Class	Coil Class
ESV	S  5/2 way / Single Coil Cv 0.9	Blank Aluminum - Aluminum die-cast S SS316 - Aluminum die-cast (only NPT 1/4 - NPT1/2 connections) C SS316 - SS316 (only NPT 1/4 - NPT1/2 connections)	A220 220VAC A110 110VAC D24 24VDC	P PT 1/4 - PF 1/2 N NPT 1/4 - NPT 1/2 M PT 1/4 - M20x1.5	Blank KC Ex d IIC T6 / T5 F IECEx / ATEX Ex d IIC T6 / T5	Blank Class F H Class H (only AC Voltage)
	D  5/2 way / Dual Coil Cv 0.9					
	3  5/2 way / N.C. Orifice 1.7					
	31  3/2 way / N.C. Cv 0.9					
	32  3/2 way / N.O. Cv 0.9					

Ex) **ESV - S - A220P** : 5/2 way single coil , Aluminum - aluminum die-cast , 220VAC , PT1/4-PF1/2 , KC Ex d IIC , Class F coil

ESV-S

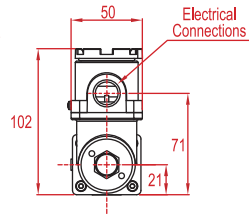

Dimensions

Symbol

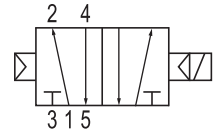
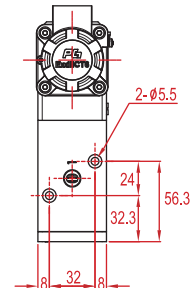
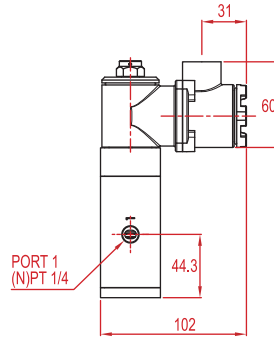
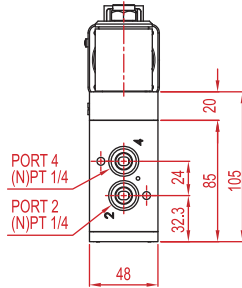
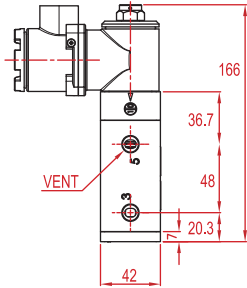

ESV-D

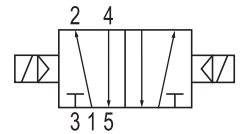
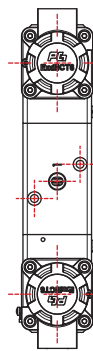
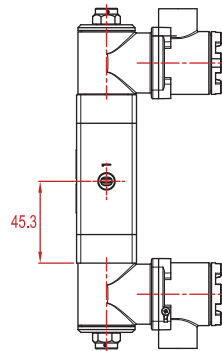
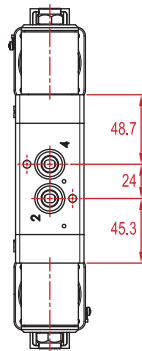
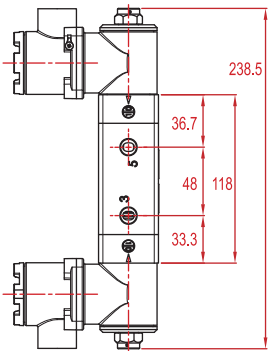

ESV-31 / 32

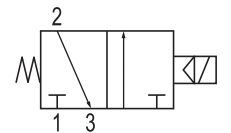
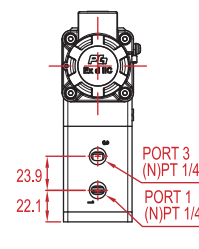
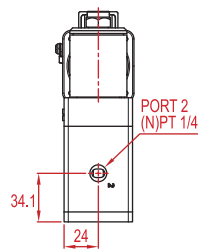
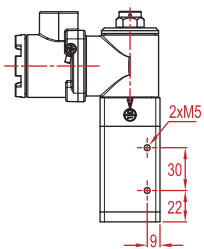

ESV-31
< Normaly - closed >

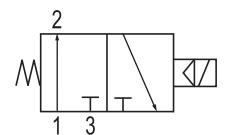

ESV-32
< Normaly - open >

ESV-3

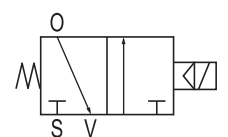
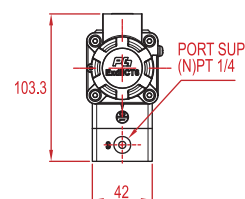
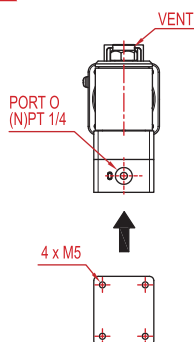
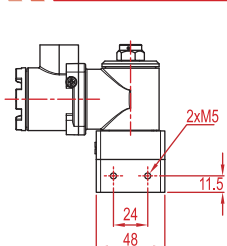

Solenoid Valve (5/2 way, Cv 1.7)



Weatherproof to IP65

- ▶ 5 port pilot / no lubrication
- ▶ Excellent durability
- ▶ Suitable for operation of even large-sized actuators with large effective section area of valve
- ▶ Suitable for PLC control system and computerized system due to a low power consumption
- ▶ Direct NAMUR mounting type

Specifications

Model		ESV10 - S	ESV10 - D
Fluid		Air, Inert Gas	
Pneumatic Connections		PT(Rc) 1/4 / NPT 1/4 / PF(G) 1/4	
Electrical Connection(s)		PG9	
Effective Sectional Area(Cv)		31.2 mm ² (1.7)	
Operating Pressure Range		1.5 - 9 bar	
Maximum Operating Frequency		5 cycle / sec.	
Operating (Response) Time		Less than 30ms	
Lubrication		Non-lubricant (if necessary, turbine oil ISO VG32 or equivalent recommended)	
Manual Operation		Non-lock push type	
Power	DC	2.8 W	
Consumption	AC	4.5 / 3.6VA (50 / 60Hz)	
Voltage Fluctuation Tolerance		± 10% of applicable voltage	
Operating Temperature		+5°C - +60°C	
Coil Insulation Class		Class F	
Protection Class		IP65	
Applicable Cylinder Size for Reference		Ø32 - Ø125	
Weight		330g	410g

Mounting

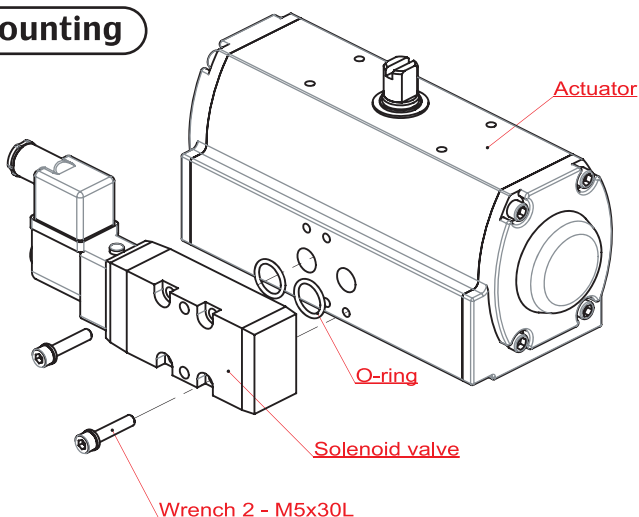

Solenoid Valve (5/2 way, Cv 1.7)

How to Order

ESV10

Coil Type

Pneumatic Connections

Operating Voltage

Wiring Method

Description	Code	Description	Code
Coil type :	S : Single coil (return type) D : Dual coil (hold type)	Operating Voltage :	1 : AC 100/110V 50/60Hz 2 : AC 200/220V 50/60Hz 3 : DC 24V 4 : DC 12V 5 : DC 24V
Pneumatic Connections :	R : PT(Rc) 1/4 N : NPT 1/4 G : PF(G) 1/4	Wiring Method :	D : DIN connector Z : DIN connector with lamp and surge killer

Symbol of Operation

Single Coil (return type)

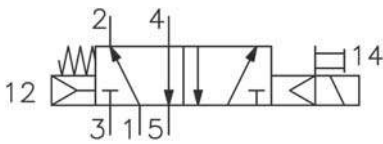

Dual Coil (hold type)

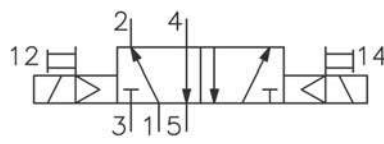

Dimensions

Single Coil Type

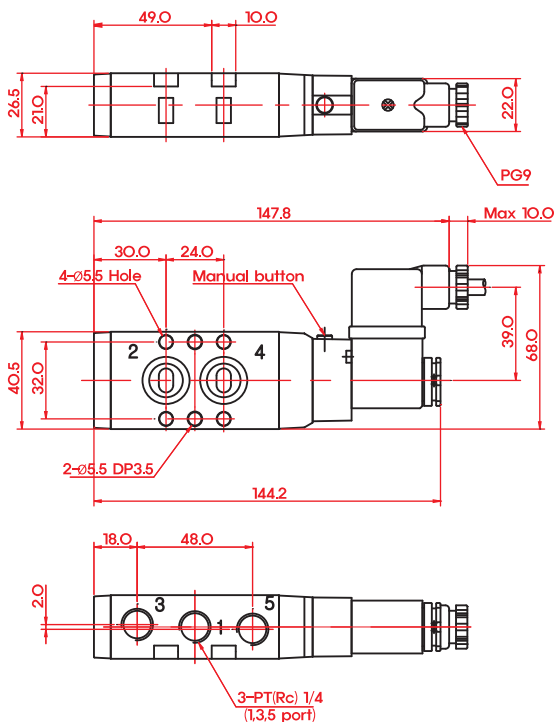

Dual Coil Type

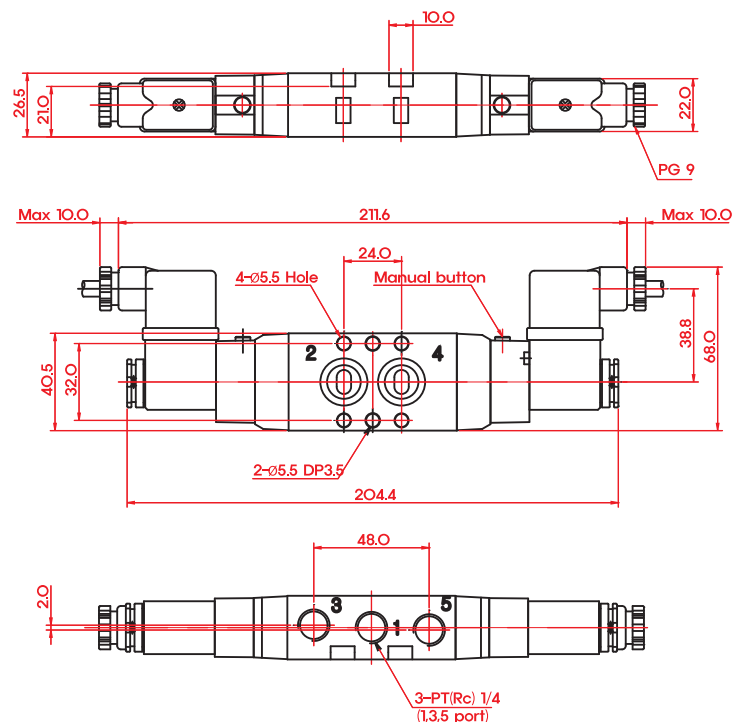



All-Technik Bldg. Lot 11 Block 36 San Antonio Avenue
San Antonio Valley Sucat Parañaque City Philippines 1715
Tel. No.: (+632) 8829-4849; 8829-4850; 8825-2563
www.alltechnik.com www.atpneumatik.com